

RESIDENTIAL- POOL INFORMATION

Pool > Any structure intended for recreational bathing or swimming that may contain water over 24 inches deep, including in-ground, on ground or above ground pools.

Required Technical Information to be Submitted with Application

In-Ground – SUBMIT

- 1> 2 copies of plot plan showing proposed pool, equipment, fence, and accessory structures with regards to home. Show all distances from adjacent property lot lines and distance from septic and well systems. Show any other existing structures.
- 2> 2 copies of pool construction drawings
- 3> 1 copy of fencing style and sizes with height and self-closing & latching gate.
- 4> 1 copy of equipment specifications

Above Ground – SUBMIT

- 1> 1 Copy of equipment specifications
- 2> Pool size, style and wall height
- 2> Fencing style when required
- 4> Ladders or steps must meet barrier requirements

Heated Pools – 1 Copy of heater specifications

Hot Tubs and Spas – Tub or spa specifications and UL listing of cover or fencing style to meet barrier requirements

Construction Requirements per 2006 International Residential Code

Sample: Electrical Requirements for Above Ground Pools

Pool equipment rated 20 amps or less may be connected by flexible cords NOT exceeding 3 feet in length, to a GFCI protected receptacle between 5-10 feet from the inside of the pool wall . Receptacles located here must be single and of the locking and grounding type and ONLY for related pool equipment. Timers and switches are allowed when direct wired. At least one standard 125-volt, 15 or 20 amp receptacle, GFCI protected, supplied by a general purpose branch circuit shall be located at least 10 feet but NOT MORE than 20 feet from the pool wall. All metal parts of the pool and all metal surfaces within 5 feet shall be bonded together with #8AWG copper wire. This includes pumps, motors and heaters unless of the DOUBLE Insulated type.

Storable pools with a longer pump cord are acceptable as long as the cord is plugged into a GFCI receptacle beyond 10 feet from the pool water surface.

EXTENSION CORDS ARE NEVER PERMITTED AT ANY TIME

Please consult the adopted PA UCC ACT 45 for all codes that apply to pool installations

All barrier and guarding requirements are applicable to all pool types.

Barrier requirements are defined in Appendix G of the IRC

IN-GROUND POOL ELECTRICAL REQUIREMENTS ARE DEFINED IN CHAPTER 41 OF THE 2006 IRC, PLEASE CHECK WITH A COMPETENT CONTRACTOR.

STATE LAW REQUIRES POOLS TO HAVE FINAL INSPECTIONS OF UCC COMPLIANCE BEFORE BEING USED

ABOVE GROUND POOLS

HOUSE

May be greater than 20 feet from pool

Call inspector if anything is not understood

ONE STANDARD GFCI OUTLET MUST BE PLACED IN THIS 6ft TO 20ft RANGE

20ft

Switches and timers may Also be placed in this area

THE POOL PUMP OUTLET OF THE TWIST-LOK TYPE MAY BE PLACED IN THIS 6ft TO 10ft RANGE

10ft

The Twist-lok Outlet for pump Must Be a GFCI protected circuit

NO OUTLETS MAY BE PLACED LESS THAN 6ft FROM THE POOL WALL

All device covers Must be Water Tight IN-USE TYPE

6ft To 10ft

POOL

All pools, includes storable, holding more than 24 inches of water depth
Pools with double insulated pumps allowed longer cords & must plug into GFCI beyond the 6ft range of pool wall

Pump may be placed in this space but the Cord Cannot be longer than 3 feet

#8 Copper wire bond shall be connected to the pump ground lug and one support member of the pool wall

GUARDING REQUIRED

All areas of the pool wall top cap must be 48 inches or greater above the grade level when standing within 18 inches in width at pool side OR a fence or other barrier must be installed to increase the height to 48 inches above grade.

Stairs must be removable or lockable in a non-useable position or self-closing & latching gates.

IMPORTANT SAFETY INSTRUCTIONS



Swimming Pool Products

1871 Aspen Circle • Pueblo, Colorado 81006 • Phone 719-544-9544



LISTED
40YZ

PoolBond - Water Bonding Fitting

Model #: PB-2008

Installation and Safety Instructions

For Any Questions Call 1-800-748-2770

(Patent Pending and UL Listed)

READ AND FOLLOW ALL SAFETY INSTRUCTIONS

Included: One PoolBond fitting, one bonding lug, Fitting Type: 1" NPT male pipe thread.

Application: PoolBond can be installed on swimming pools, spas, bathtubs, ponds and fountains. PoolBond will effectively connect the water in pools, spas, and fountains to the equipotential bonding system. **Important:** PoolBond must be installed at an elevation below the water line to insure that the water remains bonded when the filtration system is not operated. Installation is shown for an in-ground swimming pool. On other installations, the same guidelines apply.

Where to Install: PoolBond can be installed at any location in the pool's filtration piping as long as the elevation of the PoolBond fitting is at least 3 inches below the elevation of the pool's water surface. Always install PoolBond in an orientation that avoids trapped air. Three typical installations are illustrated below. Care must be taken to properly pressure test all plumbing prior to burial of lines. Review "Assembly Procedure" for proper tightening of the PoolBond fitting in plastic plumbing. PoolBond is cast from a corrosion resistant bronze alloy and will not corrode under normal swimming pool chemical conditions including salt system sanitation.

1. Install in Skimmer:

- Using proper sized plastic bushings, PoolBond can be installed in one of the threaded skimmer outlet ports. See "Assembly Procedure" for proper tightening of PoolBond.

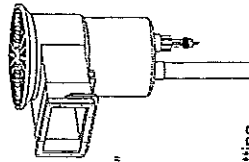

2. Install in a return line:

- PoolBond can be installed in the filtration return line adjacent to inlet fitting. Avoid installations that could trap air.
- If access is required for service purposes, a sprinkler system valve box can be used for access.

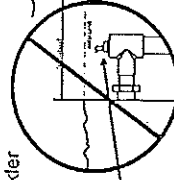
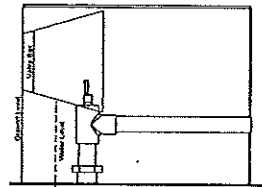

Do Not install as shown
Trapped air will prevent proper contact with water

3. Install on suction side adjacent to equipment pad:

- Install on suction side plumbing at least 3" below water level.
- If access is required for service purposes, a sprinkler system valve box can be used.

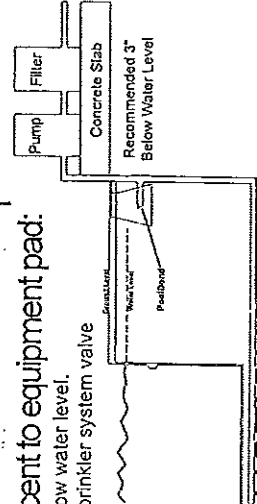

SAVE THESE INSTRUCTIONS

Bond Wire Installation: Connect a solid #8 copper bonding wire (not supplied) from the bonding system. The copper wire should also connect the metal parts of all electrical equipment and all metal fittings, parts, and piping of the swimming pool, spa, pond, or fountain within 5 feet of the inside wall of the pool or spa and the pond or fountain structure. Always use 2 wrenches when tightening the split bolt to avoid bending the wire receptor tab on the PoolBond fitting. Tighten split bolt to 120 in-lbs.

Always use 2 wrenches

Never use 1 wrench

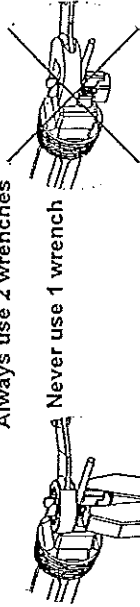

Wire Receptor Tab

#8 Solid Copper Bonding Wire

Split Bolt

1 inch Male Pipe Thread

PoolBond Casting

Assembly Procedure

To properly install a male threaded pipe (metal) into a female threaded fitting (plastic) you should first thread the pipe into the fitting (dry fit) until the pipe just starts to tighten on the pipe thread taper. Count the number of turns that it takes; disengage the two parts (document this number).

Wrap Teflon tape and/or apply Pipe sealant on the male thread in the normal way and reassemble to the number of turns required to disengage the two parts. NOW tighten two more turns STOP.

Caution: Overtightening PoolBond Fitting can Damage Plastic Plumbing.

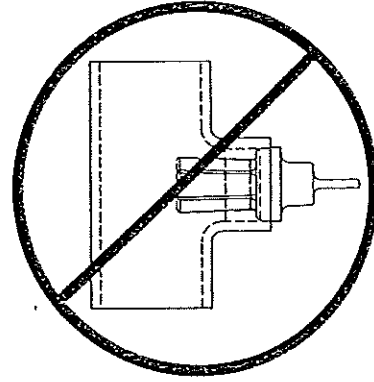
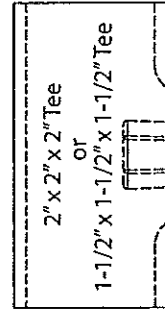

Female Reducing Adapter
1-1/2" SOC x 1" FIPT
OR
2" SOC x 1" FIPT

2" SOC x 2" SOC x 1" FIPT
OR
1-1/2" SOC x 1-1/2" SOC x 1" FIPT

RECOMMENDED
Installation for 1-1/2" or 2" Pipe

NOT RECOMMENDED



Swimming Pool Products

1871 Aspen Circle • Pueblo, Colorado 81006 • Phone 719-544-9544

PB-2008 Pool Bond

- Copies with National Electrical Code 680.26(C)
- UL Listed
- Water Bonding Fitting

Parts List	
QTY	Description
1	PB-2008
1	Burndy Split Bolt